



Tordivel as
Storgata 20, N-0184 Oslo, Norway
www.scorpionvision.com

SCORPION VISION SOFTWARE® VERSION 6 PRODUCT OVERVIEW

Scorpion Vision Software® is an independent and open software tool for industrial vision. It is the first configurable 3D framework for machine vision.

The system gives the user the choice of a small form factor with the Sony SmartCam or the power of a quad core PC.

The system is founded on top of a standard Windows 2000/XP PC platform.

It is cost effective benefitting from the processing power of the Intel processors, low cost - high quality firewire cameras and the possibility of connecting multiple cameras to one PC.

Scorpion solves tasks within robot vision, label inspection, assembly verification, color identification and gauging without any programming.

Scorpion Vision Software® is a family of products:

SCORPION LITE - for simple tasks replacing sensors

SCORPION BASIC - for colour processing and assembly verification

SCORPION STANDARD - for high precision gauging, robot vision and label inspection

SCORPION VISION SERVER - running multiple camera systems on quad core server

SCORPION MAINTENANCE - for maintaining and testing profiles on a separate computer

SCORPION IMAGE LOGGER - automatic image capture, database access and image saving

SONY SCORPION SMARTCAM - configurable machine vision in a small form factor

SCORPION LITE

Scorpion Lite is designed to solve simple tasks. With its low price and ease of use, a production engineer can measure dimensions and diameters, count and check presence of objects and color inspection and verification.

In many cases Scorpion Lite and a low cost USB or FireWire camera will replace hardware sensors due to the greater flexibility and the higher performance of a vision system.

Scorpion Lite is installed on a standard windows PC and will in many situations coexist with other applications on a PC. Scorpion Lite is a complete vision system for one VGA camera. Multiple cameras can be connected adding camera licenses.

SCORPION BASIC

Scorpion Basic is a Scorpion Lite with one SVGA camera license - resolution 800 x 600 and Toolbox extended with Geometry and Reference Tools. With the Geometry tools new points and lines can be constructed and measured from detected details. Reference tools handle rotation and gauging in engineering units.

This version competes very well with vision sensors typically if there is a need to handle many product variants and variations.

SCORPION STANDARD

Scorpion Standard's Toolbox contains all the Advanced Tools including a large range of sophisticated multiple polygon ROI's tools, 5th order camera calibration to eliminate lens distortion and the very powerful LineFinder, capable of finding a multitude of lines.

High resolution and high quality cameras can be used. This version targets Label Inspection, Robot Vision, Inspection of Printed Circuits and high precision 2D gauging including laser measurements.

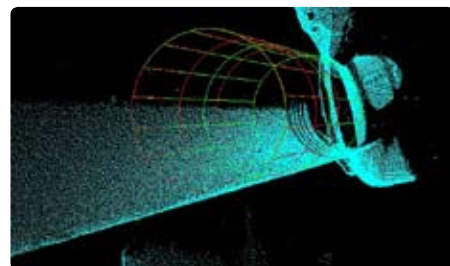

3D support is available as an option to all Scorpion versions. The 3D option contains 25 new tools.

SCORPION VISION SERVER™

The Scorpion Vision Server™ can run tens of vision sensor tasks or up to four demanding machine vision applications on one industrial vision server. Important features are: multiple Scorpion applications connected to a specific CPU core and remote debugging of the active system.

SCORPION MAINTENANCE

Scorpion Maintenance is used to develop, test and modify Scorpion Vision System on separate PC using images stored on disk.

SCORPION IMAGE LOGGER

The Scorpion Image Logger provides exciting product traceability for manufacturers. Scorpion Image Logger can capture and store images of every manufactured product in real time. It can capture images from multiple cameras connected to one PC.

SONY SCORPION SMARTCAM

In close cooperation with Sony, we have integrated the Scorpion Vision Software® into the XCI-SX1 SmartCam. A full version of Scorpion running on top of the Windows XP operating system, processes the images inside the camera. The combination of high resolution images and Scorpion's world class gauging tools is ideal for high precision measurements and robot vision applications.



SCORPION VISION SOFTWARE® PRODUCTS

SCORPION ROBOT VISION

Flexible automation means robots, automation and vision working together. This reduces cost and increases the flexibility and possibility to produce several product variants in one production line at the same time - 24 hours a day - with profits. The vision system's ability to locate and identify objects are critical elements in making these systems.

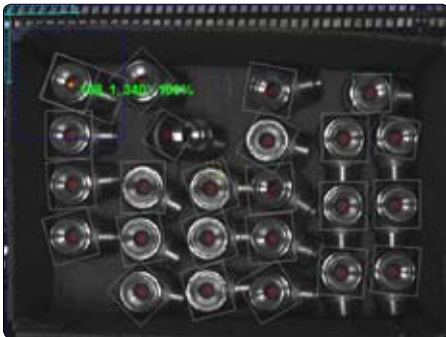

A box of valves. Scorpion sends the valve positions to the robot.

SONY SCORPION ROBOT INSPECTION

Sony desktop robot's winning combination of superior performance and compact size, combined with Sony Firewire cameras and Scorpion Vision Software® are redefining the meaning of optical inspection systems. Advanced inspection systems are put into operation in the matter of days using only standard components.



Sony desktop robot, firewire cameras and Scorpion Vision Software working together.

3D MACHINE VISION

Application areas for 3D machine vision are 3D robot vision, volume measurement, automotive part measurement and 3D object location and identification.

3D MODELLER

High precision 3D modelling using structured light makes 3D measurement, 3D robot vision, random bin picking and 3D assembly verification feasible for everyone.

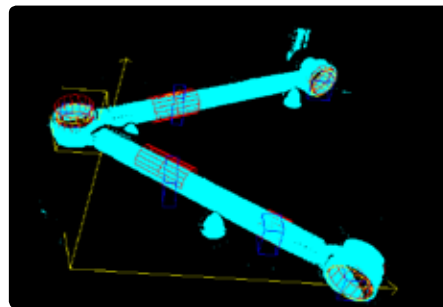

Measurement on an automotive V-stay with the Scorpion 3D Modeller

3D SCANNER

The 3D scanner creates accurate 3D product models. The 3D scanner uses multiple laser triangulation profiles working in a common 3D coordinate system with the highest accuracy. A scan is fast and creates models with a resolution down to 0.01 mm.

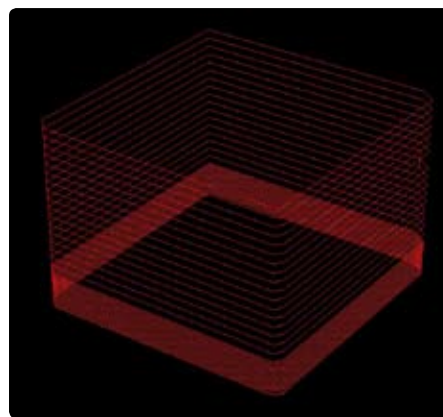

3D scan of wafer block

SCORPION DESKTOP AOI

Scorpion Desktop AOI (Automatic Optical Inspection) is a flexible general purpose vision system ideal for sample control of products. A ready to use unit consists of a Scorpion license, a standard firewire camera, a macro lens and illumination and an optional Sony Desktop Robot.



Scorpion Desktop AOI with Sony SmartCam and Robokid Desktop Robot

SCORPION BARCODE

Scorpion Barcode is a camera based automatic barcode reader application supporting multiple readers on one PC. Scorpion Barcode is a Scorpion Lite with an integrated Euresys EasyBarCode™ reader software module.



Scorpion Barcode

SCORPION MATRIXCODE

Scorpion MatrixCode is a camera based automatic 2D MatrixCode reader application supporting multiple readers on one PC. Scorpion MatrixCode is a Scorpion Lite with an integrated Euresys EasyMatrixCode™ reader software module.



LASER PROFILE MEASUREMENT

The Scorpion Laser Profile Measurement System is a single camera 3D measurement system dedicated to the verification of object geometry and dimensions.

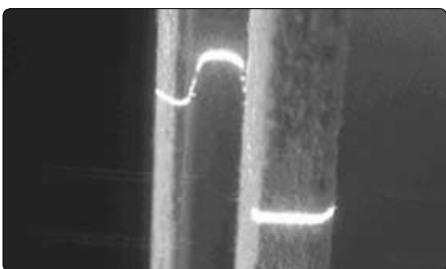

The example above shows the laser profile generated by the edge of a Medium Density Particle board.

LASER LENGTH MEASUREMENT

The Scorpion Laser Length Measurement system is a general purpose length measurement system.

Here it is used for in-line measurements of lamella lengths. The system assumes that the other end of the object has a fixed position and direction during the measurement.



In-line measurements of lamella lengths

SCORPION CAPTURE

Scorpion Capture can display and capture images from Windows cameras. Included are: standard DirectX interface to Windows cameras, image viewer with zoom and manual measurement, image history list for manual inspection and storing of selected images to disk and automatic image logging.

Read more on other Scorpion Vision Software® products on the web, www.scorpionvision.com.

SOLAR CELL WAFER INSPECTION

The Solar Cell Wafer Sawmarks Measurement System measures wafers with low noise, high sensitivity, high repeatability and high resolution. Unique shadow measurement techniques, cancelling the effects of the crystal pattern, and Scorpion Vision Software are used to find the wafer sawmarks.

The system is based on the third generation 100% automatic quality control systems running at REC Wafer's plants in Glomfjord and at Herøya, Norway, since 2001.



Solar cell wafer inspection system

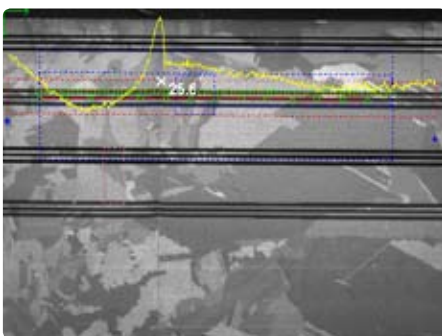

Screen image showing typical sawmark changes across a solar cell wafer. A 25.6 µm sawmark is found.

COLOUR IDENTIFICATION

The system picks the best colour match from a set of reference images and calculates the color coverage of the inspected item. The SurfaceAnalyzer is a unique tool performing color, texture and shape classification of multiple objects.

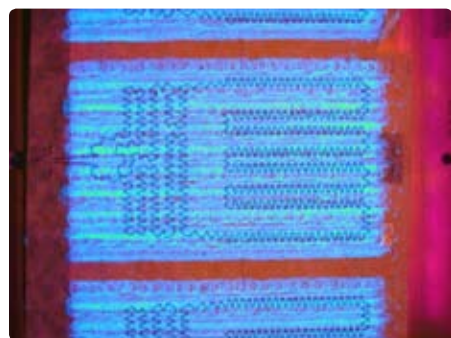

Glue detected with colour identification.

IMAGE LOGGER

Use Scorpion Image Logger to digitize, tag and store video data from multiple video sources in real-time.

Scorpion is capable of acquiring digital images from a broad range of commercial video cameras, optionally tagging the images with real-time data from external data sources such as GPS receivers and OPC devices, before storage to JPG or BMP disk files.

Successful applications have been created using Scorpion with GPS receivers for tagging real world data to images or documenting lack of defects prior to shipments in automotive traceability environments.



Image logger system collecting data for a national road information base. A camera positioned on the roof of a car captures an image every 20 meter. The GPS coordinates are saved with the image.



Tordivel AS
Storgata 20, N-0184 Oslo, Norway
www.scorpionvision.com

TRAINING AND SUPPORT

SUPPORT POLICY

The primary source of support is www.scorpionvision.com and its FAQ. On the Scorpion CD there is numerous Scorpion profiles demonstrating and explaining how to use Scorpion. Question about Scorpion can be sent to: support@tordivel.no

All users can register for download privileges to get access to the electronic Scorpion CD located on the Web. The latest official version of Scorpion will always be available together with the latest documentation and the latest course material. Our Scorpion Newsletter is sent to registered users once or twice per month. The Newsletter provides important information about the software: new releases, new features, case studies, events and more.

The extensive FAQ – Frequently Asked Questions – are available on-line and as part of the integrated html-help file. Unanswered questions are handled in hours and can be submitted using the web support form or by sending an e-mail directly to vision@tordivel.no.

When Scorpion users have potential vision tasks - we can help. Submit a description of what you want to do and maybe some images to vision@tordivel.no. We will then take a look, give you some advice and maybe provide a skeleton solution profile using Scorpion. With Scorpion installed, this profile can be run on your own computer. 30 days free e-mail and phone support are included in the Standard and Enterprise versions of Scorpion.

For more information:

Tordivel AS
Phone +47 2315 8700
Fax +47 2315 8701
office@tordivel.com
www.scorpionvision.com



Scorpion Vision Software® is a registered trademark of Tordivel AS. Scorpion Vision Server™ is a trademark of Tordivel AS.
© 2003-2007 Tordivel AS

We want to provide our Scorpion Vision Software users the best available support 365 days a year. To facilitate a seamless start of using Scorpion Vision Software and to provide efficient support to all users, several options of training, support, upgrades and special kits, are available.

SCORPION VISION SOFTWARE TRAINING

Our training courses are designed to make the participants capable of building their own vision systems. All training material is found on the Scorpion CD. The courses are frequently arranged by Scorpion distributors and System Integrators. On request they can be arranged on-site adapted to the customer's requirements. The Scorpion User Forum is an annual event lasting for two days. This event gives you the possibility to discuss Scorpion with other users and to benefit of their experience and to meet the people responsible for Scorpion design, development and implementation. Every year, one and two days workshops on important application areas, like robot vision and label inspection, is conducted with a practical and hands on focus.

SCORPION STARTER KIT

The Scorpion Starter Kit is a discounted bundle of Scorpion Enterprise, Scorpion Maintenance, a two days Scorpion Introduction Course and an optional firewire camera with a lens. One starter kit is available per customer /factory.

SCORPION ROBOT VISION STARTER KIT

The Scorpion Robot Vision Starter Kit is a discounted bundle of Scorpion Enterprise, a two days Scorpion Introduction Course and a high quality Sony firewire camera. This is everything you need for bringing your Scorpion robot vision project to life. One starter kit is available per customer/factory.



FREE DEMO SOFTWARE

Demo software can be downloaded from our web site www.scorpionvision.com. A demo license is valid for 30 days. The demo licence is a full version of Scorpion with the following limitations: Automatic Mode is limited to 30 minutes and the application must be terminated and restarted after 4 hours of operation.

SYSTEM LISENCE

A system license include one, two or unlimited camera connections with a specified resolution depending on the type of product purchased. A system license is linked to the computer using the network MAC address.

VERSION UPGRADE

A version upgrade after purchase is available at 25% of the current list price.
Prod.no. 10-097.

PRODUCT UPGRADE

The upgrade price is the actual price difference between the two products when ordering added 10%. Prod. no. 10-099.

TOOL UPGRADE

All Scorpion licences except Scorpion Image Logger can be upgraded with a tool upgrade.
Prod. no. 10-091, 10-094.

CAMERA UPGRADE – CAMERA CONNECTIONS AND RESOLUTION UPGRADES

Additional camera licenses and resolution upgrades can be added to System License with limitations. More information about product capabilities is found in the product overview table at the end of this document.
Prod. no. 10-090, 10-092, 10-093.

MAINTENANCE CONTRACT

A Scorpion Vision Software Maintenance Contract includes one year with free version upgrades, free e-mail support including access to the Scorpion Vision software support web. Product no. 10-098.